



Stainless design.
Stellar performance.
Superior value.

Arctic Air® Refrigeration Products Catalog

Including Specifications and Dimensional Line Drawings





Introduction

TO OUR ARCTIC AIR® CUSTOMERS

For over 20 years Arctic Air has been a trusted brand in the U. S. commercial refrigeration market. We have strived year after year to provide a quality product at economical prices to our customers. In addition, as a family owned American company, it is our priority to maintain the high standard of customer service and support to our customers that they deserve and have come to expect. Finally, at Arctic Air it is our ongoing goal to maintain our respected standing in the commercial refrigeration industry by continuing to focus on product quality improvements while adding newly developed product offerings and continuing to grow with our customers.

Thank you again for your continued support.

Sincerely,

Walt Broich, Jr
President

WARRANTY SERVICE

If warranty service is required, please contact our warranty line directly at 1-855-431-5558.

Information required at time of call is model, serial number, and batch number from sticker inside or on back of the unit. Also required will be name, address, contact info, and description of problem. Arctic Air Warranty Department will take all information and will get a local service agent dispatched as soon as possible.

For complete warranty information see warranty page on back.

ARCTIC AIR RETURN POLICY

Arctic Air will only accept product returns on product that is in **original, unopened** package and was not shipped more than 30 days prior to return.

If product is in **original, unopened** carton, then we will accept returns to our MN warehouse. Returns are accepted with a 15% restocking fee. The outbound and return freight would be paid by party returning the product.

Credit will be given upon confirmation and inspection of returned products and they are determined to be in proper undamaged and unopened condition.



Product Index

Single and Two Door Reach-in Refrigerators and Freezers.....	2
Single and Two Door Glass Reach-in Refrigerators	4
S/S Pan Rack.....	6
Single Door Economy Refrigerator and Freezer.....	8
Refrigerated Counter-Top Prep Units	10
Refrigerated Compact Counter-Top Prep Units.....	12
Refrigerated Chef Bases	14
Pan Capacity for Version 4 Chef Bases.....	16-17
Undercounter/Worktop Refrigerators and Freezers	18
Refrigerated Pizza Prep Tables.....	20
Refrigerated Sandwich/Salad Prep Tables	22
Refrigerated Mega-Top Sandwich/Salad Prep Tables.....	24
Refrigerated Back Bar Coolers.....	26
Refrigerated Glass Door Back Bar Coolers.....	28
Refrigerated Direct Draw Beer Coolers	30
Refrigerated Direct Draw Keg Capacity Guide.....	31
Refrigerated Horizontal Bottle Coolers.....	32
Glass Froster	34
Terms and Conditions.....	37





Single and Two Door Reach-In Refrigerators and Freezers

- Electronic thermostat with external digital LED display for accurate control and easy reading.
- Interior cabinet is bright white epoxy coated aluminum liner with full high-grade stainless steel floor with coved corners.
- Three adjustable, heavy-duty epoxy coated wire shelves.
- Self-contained capillary tube system using environmentally friendly CFC free refrigerant.
- Exterior cabinet construction consists of full stainless steel front and sides.
- Condensate heating element built into condensate pan for efficient evaporation of excess water.
- Bottom mounted compressor for more efficient operation in coolest area of the kitchen.
- Front accessible, bottom mounted condensing unit is mounted on slide out rack for easy maintenance.
- Easy to mount casters (two lockable) are standard with all units.
- Self-closing doors that remain open at 90 degrees.
- Magnetic door gasket is removable and replaceable without tools.
- Field reversible, lockable door* with foamed-in-place recessed handle.
- Larger fan motors and blades for more efficient air flow ensuring faster recovery times.

* AR23/AF23 require additional door



**AR23
AF23**



**AR49
AF49**

reversal kit 65118K

- **#64900K Sheet Pan Rack**
Free standing full height rack holds 14 full size sheet pans. Fits all s/s reach-in models. (See page 6)

- Tested to NSF Standard 7 requirements for open food storage.
- Full two year parts and labor warranty and a five year compressor warranty.



Approved models:
AR23, AF23
AR49, AF49

Model Number	External Dimensions			Doors	Shelves	Cubic Feet	Temperature Range	Cord Length	HP	Amps	NEMA Plug	Crated Weight (lbs.)
	Width	Depth	Height									
AR23	26.75"	32.75"	82.75"	1	3	23	33°F to 41°F	9'	1/5	3	5-15P	320
AF23	26.75"	32.75"	82.75"	1	3	23	-11°F to -1°F	9'	4/5	8	5-15P	335
AR49	54"	32.75"	82.75"	2	6	49	33°F to 41°F	9'	1/3	4.5	5-15P	470
AF49	54"	32.75"	82.75"	2	6	49	-11°F to -1°F	9'	7/8	9	5-15P	500

PHONE 952-941-2270
FAX 952-941-3066
WEB www.arcticairco.com



DIMENSIONAL DRAWINGS

Specifications subject to change without notice.

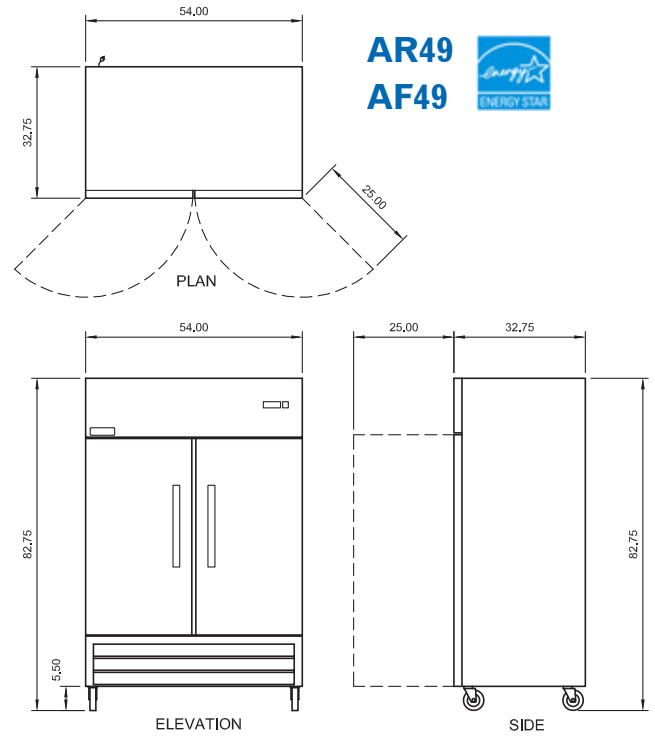
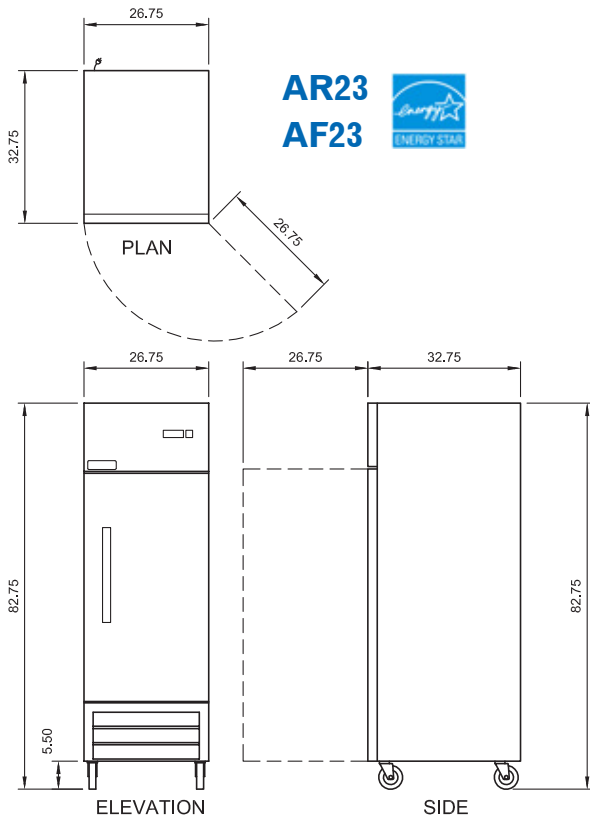



Single and Two Door Glass Reach-in Refrigerators

- *Electronic thermostat with external digital LED display for accurate control and easy reading.*
- *Interior cabinet is bright stainless liner with full high-grade stainless steel floor with coved corners.*
- *Three adjustable, heavy-duty epoxy coated wire shelves.*
- *Self-contained capillary tube system using environmentally friendly CFC free refrigerant.*
- *Exterior cabinet construction consists of full stainless steel front and sides.*
- *Condensate heating element built into condensate pan for efficient evaporation of excess water.*
- *Bottom mounted compressor for more efficient operation in coolest area of the kitchen.*
- *Front accessible, bottom mounted condensing unit is mounted on slide out rack for easy maintenance.*
- *Self-closing lockable doors.*
- *Magnetic door gasket is removable and replaceable without tools.*
- *Larger fan motors and blades for more efficient air flow ensuring faster recovery times.*
- *Easy to mount casters (two lockable) are standard with all units.*
- *Tested to NSF Standard 7 requirements for open food storage.*
- *Full two year parts and labor warranty and a five year compressor warranty.*



AGR23



AGR49

Model Number	External Dimensions			Doors	Shelves	Cubic Feet	Temperature Range	Cord Length	HP	Amps	NEMA Plug	Crated Weight (lbs.)
	Width	Depth	Height									
AGR23	27.0"	31.25"	83.25"	1	3	23	33°F to 50°F	8'	1/3+	2.6	5-15P	330
AGR49	54.0"	31.25"	83.25"	2	6	49	33°F to 50°F	6'	1/2+	4	5-15P	500

PHONE 952-941-2270
FAX 952-941-3066
WEB www.arcticairco.com



Single and Two Door Glass Reach-in Refrigerators

DIMENSIONAL DRAWINGS

Specifications subject to change without notice.

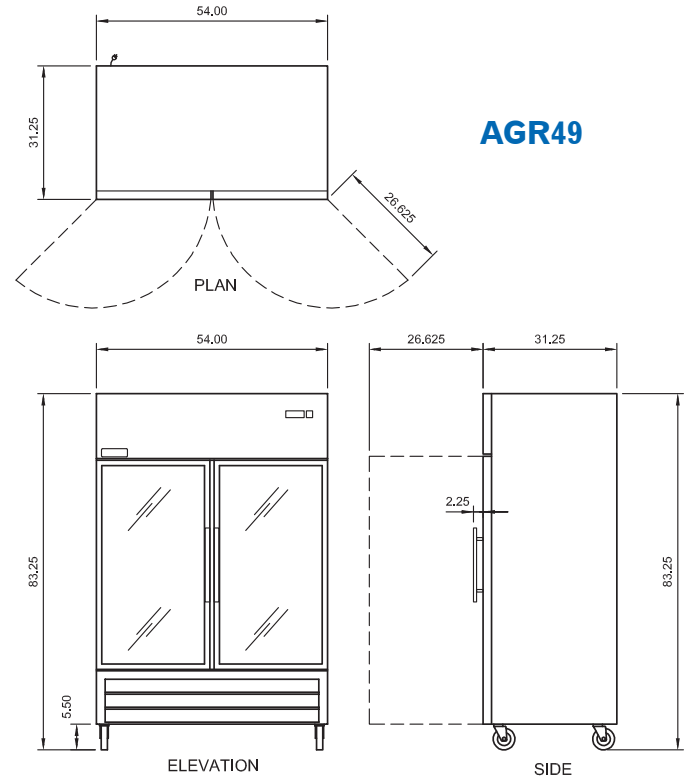
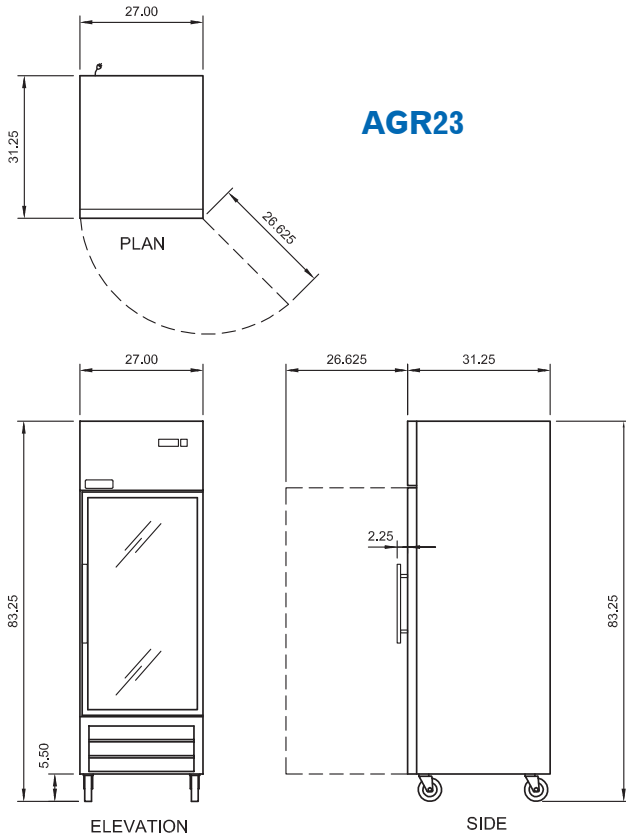

ARCTIC AIR® — A Division of Broich Enterprises, Inc. — An American Company since 1995



- *S/S welded construction*
- *Compatible with all double door units.*
- *Ships knocked down in a box via ground service. Some simple field assembly is required.*
- *Ships from Plymouth, MN.*
- *Assembled S/S pan rack lifts into the interior floor of the following units:*
 - AR23
 - AF23
 - AR49
 - AF49
 - AGR 23
 - AGR49
- **Sheet pans longer than 25.75" will not fit into reach-ins. There are no depth issues with AR49, AF49, AGR23 and AGR49 units.**

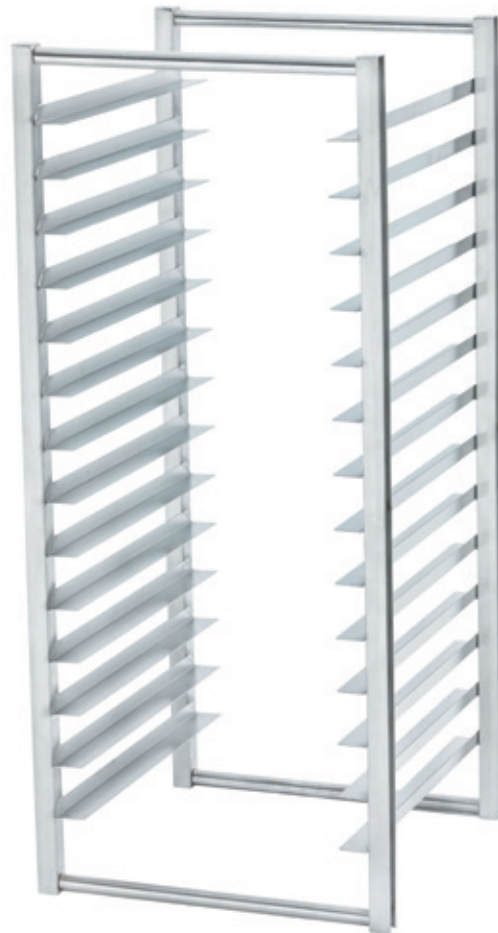

64900K

Model Number	External Dimensions			Crated Weight (lbs.)
	Width	Depth	Height*	
64900K	21"	22.5"	48"	50
Ships knocked down ground service from zip code 55447				

PHONE 952-941-2270
FAX 952-941-3066
WEB www.arcticairco.com

DIMENSIONAL DRAWINGS

Specifications subject to change without notice.

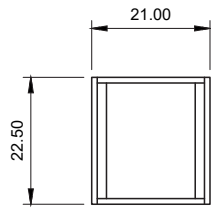

PLAN

64900K

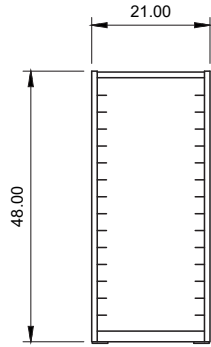

ELEVATION

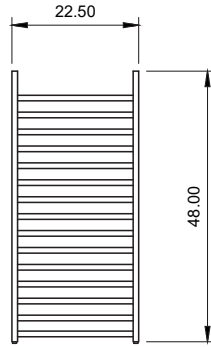

SIDE





Single Door Economy Refrigerator and Freezer

- *Electronic thermostat with external digital LED display for accurate control and easy reading.*
- *Interior sidewalls are bright white ABS liner with high-grade stainless steel floor with coved corners.*
- *Three adjustable, heavy-duty epoxy coated wire shelves.*
- *Self-contained capillary tube system using environmentally friendly CFC free refrigerant.*
- *Exterior cabinet construction consists of white epoxy coated steel front and sides.*
- *Condensate heating element built into condensate pan for efficient evaporation of excess water.*
- *Bottom mounted compressor for more efficient operation in coolest area of the kitchen.*
- *Easy to mount casters (two lockable) are standard with all units.*
- *Magnetic door gasket is removable and replaceable without tools.*
- *Field reversible, lockable door with foamed-in-place recessed handle.*
- *Larger fan motors and blades for more efficient air flow ensuring faster recovery times.*
- *Tested to NSF Standard 7 requirements for open food storage.*
- *Full one year parts and labor warranty and a five year compressor warranty.*



AWR25
AWF25

Model Number	External Dimensions			Doors	Shelves	Cubic Feet	Temperature Range	Cord Length	HP	Amps	NEMA Plug	Crated Weight (lbs.)
	Width	Depth	Height									
AWR25	30.75"	29.00"	78.00"	1	3	25	33°F to 41°F	9'	1/5	3	5-15P	310
AWF25	30.75"	29.00"	78.00"	1	3	25	-11°F to -1°F	9'	4/5	7	5-15P	325

PHONE 952-941-2270
FAX 952-941-3066
WEB www.arcticairco.com



DIMENSIONAL DRAWINGS

Specifications subject to change without notice.

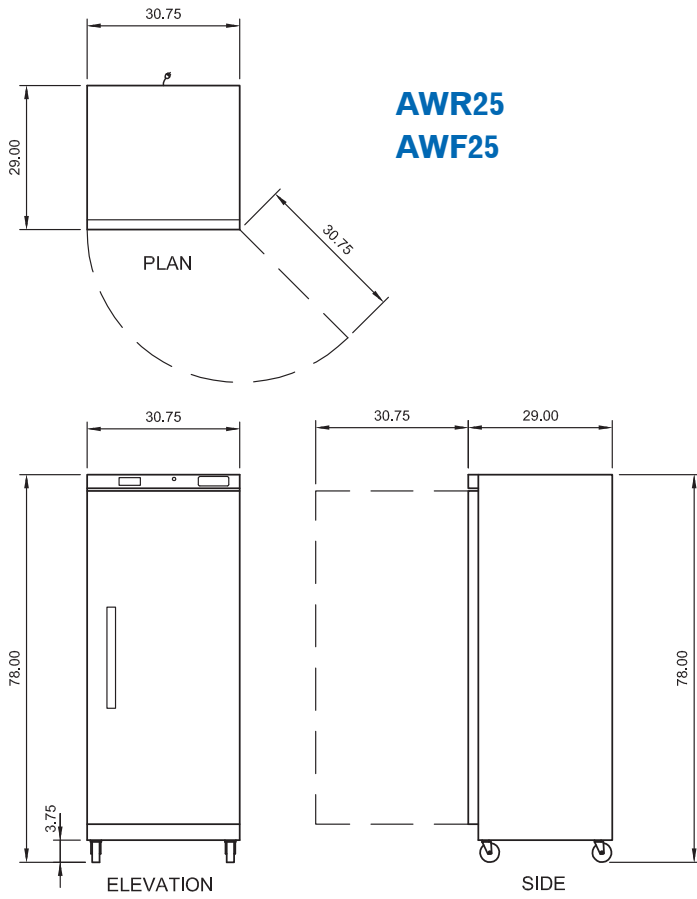

- Includes stainless cover for refrigerated area.
- Pan rail is “cold wall” not “air cooled” heat transfer.
- Interior cabinet consists of full stainless steel liner.
- Exterior cabinet consists of full stainless steel shell.
- Plastic non-scratch feet included.
- Self-contained capillary tube system using environmentally friendly CFC free refrigerant (R290).
- Includes 1/6 size 6" deep stainless pans and covers.
- Stainless pan supports included.
- Electronic thermostat with external digital LED display for accurate control and easy reading.
- Tested to NSF Standard 7 requirements for open food storage.
- Full one year parts and labor warranty.
- *NOTE: No defrost systems. ACP is designated as an “in-service” item. Unit needs to be shut off to defrost.*



ACP48

ACP40

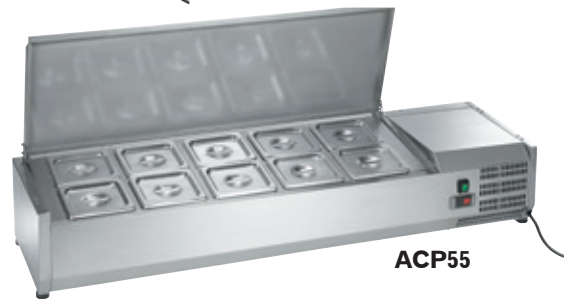

ACP55



ACP63

Optional:

Glass sneeze-guard available

- Part No. 65300K — ACP 55
- Part No. 65400K — ACP 48
- Part No. 65500K — ACP 63



Model Number	External Dimensions			Temperature Range	Cord Length	Pans (1/6 Size)	Amps	NEMA Plug	Crated Weight (lbs.)
	Width	Depth*	Height**						
ACP40	39.5"	15.5"	11"	33°F to 41°F	8'	6	1.4	5-15P	90
ACP48	47.25"	15.5"	11"	33°F to 41°F	8'	8	1.4	5-15P	100
ACP55	55.0"	15.5"	11"	33°F to 41°F	8'	10	1.6	5-15P	105
ACP63	63.0"	15.5"	11"	33°F to 41°F	8'	14	1.6	5-15P	125

DIMENSIONAL DRAWINGS

Specifications subject to change without notice.

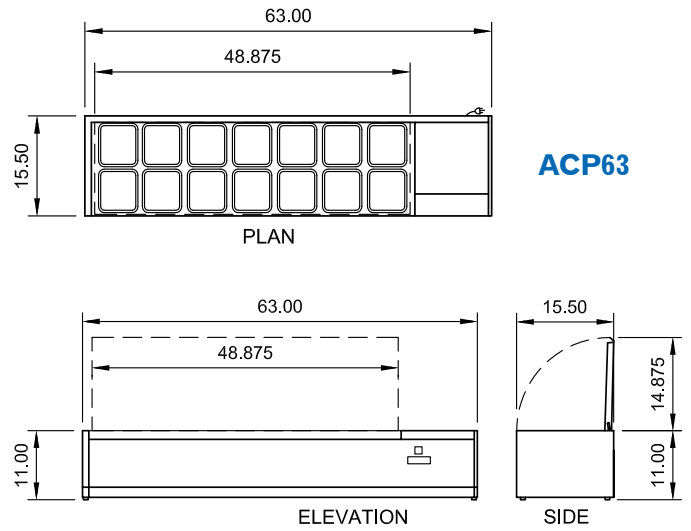
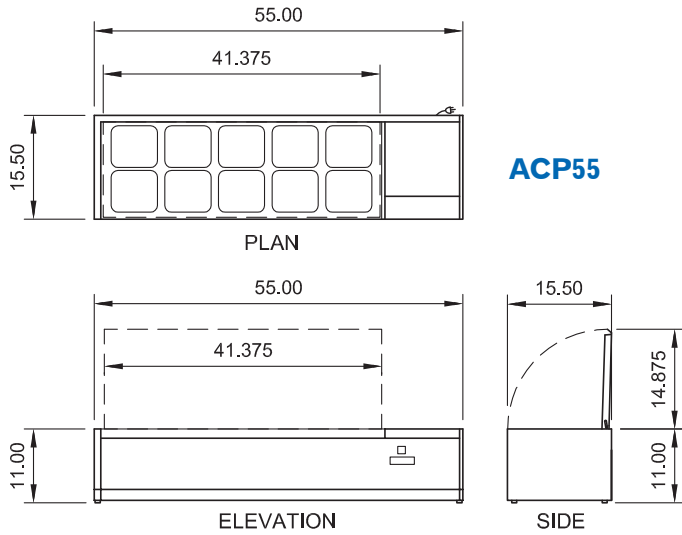
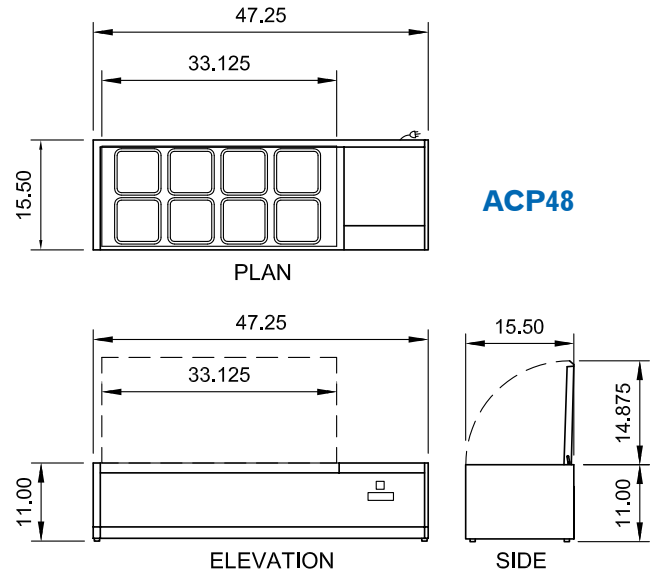
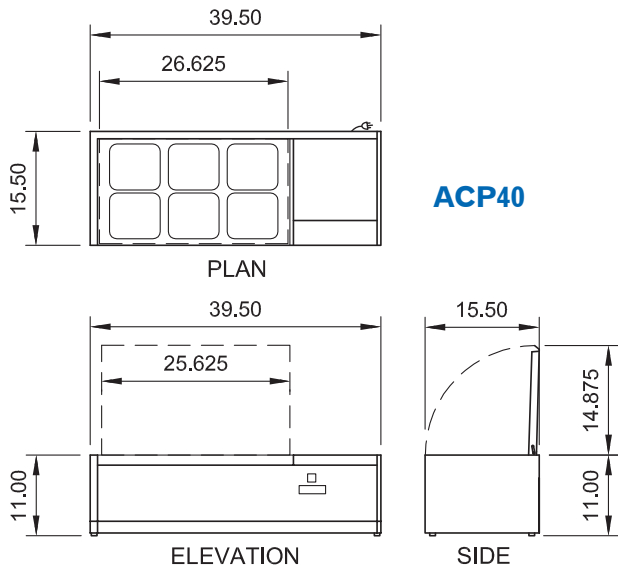



Refrigerated Compact Counter-Top Prep Units

- Interior cabinet consists of full stainless steel liner.
- Pan rail is "cold wall" not "air cooled" heat transfer.
- Exterior cabinet consists of full stainless steel shell.
- Plastic non-scratch feet included.
- Includes 1/6 size pans and covers. 6" deep back row. 4 deep front row.
- Self-contained capillary tube system using environmentally friendly CFC free refrigerant.
- Tested to NSF Standard 7 requirements for open food storage.
- Full one year parts and labor warranty.
- **NOTE:** No defrost systems. ACP is designated as an "in-service" item. Unit needs to be shut off to defrost.

Note:

Optional 4" stainless steel adjustable leg kit #69438K is available for extra purchase.



ACP4SQ



ACP8SQ

Model Number	External Dimensions			Temperature Range	Cord Length	Pans (1/6 Size)	Pan Depth	Amps	NEMA Plug	Crated Weight (lbs.)
	Width	Depth	Height							
ACP4SQ	15.0"	25.75"	9.125"	33°F to 41°F	8'	4	Front 4" Back 6"	1.4	5-15P	65
ACP8SQ	27.5"	25.75"	9.125"	33°F to 41°F	8'	8	Front 4" Back 6"	1.4	5-15P	80

PHONE 952-941-2270
FAX 952-941-3066
WEB www.arcticairco.com



DIMENSIONAL DRAWINGS

Specifications subject to change without notice.

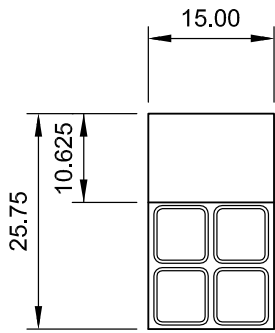

ACP4SQ

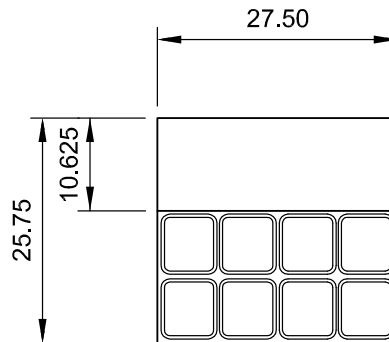
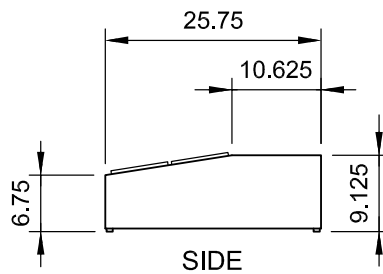
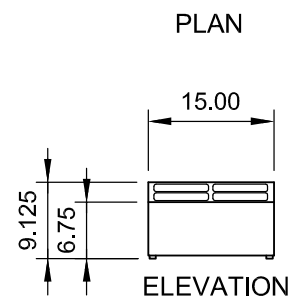

ACP8SQ

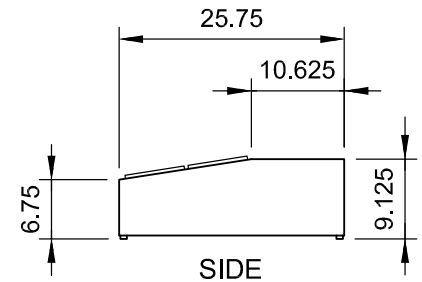
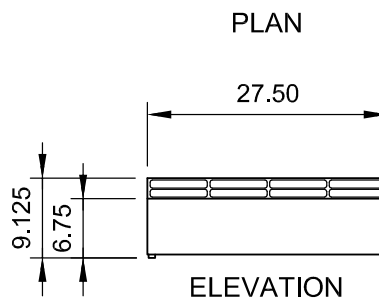

- Heavy duty stainless top is insulated with ceramic fabric layer to eliminate melting foam and heat transfer to interior of cabinet.
- Top comes with standard marine edge on all sides and has a 1" extension on each side to allow cooking equipment to sit flat.
- Exterior cabinet construction consists of full stainless front, sides and top.
- Easy to mount casters (two lockable) are standard with all units.
- ARCB72 comes standard with (6) casters.
- Front breathing.
- Stainless steel drawer facings, linings and frames. Top and bottom drawers hold up to 6" deep pans.
- Each drawer is equipped with s/s hooked adaptor bars and magnetic gaskets that are removable for cleaning.
- Heavy duty Fulterer™ telescoping cartridge drawer system.
- Self-contained capillary tube system using environmentally friendly CFC free refrigerant (R290).
- Full extension drawers allow for loading and unloading of pans without tipping them.
- Electronic thermostat with external digital LED display for accurate control and easy reading.
- Front accessible condensing unit for easy cleaning and maintenance.
- Tested to NSF Standard 7 requirements for open food storage.
- Full two year parts, labor warranty and 5 year compressor warranty included.



Recommended Operating Conditions

- Installation of a heat shield is recommended for optimum performance (supplied by others).
- Counter top cooking equipment should be used in conjunction with the manufacturer supplied legs.
- Minimum clearance of 4" required between bottom of cooking equipment heating element and unit top. Failure to provide clearance voids manufacturer warranty.

Model Number	External Dimensions			Drawers	Full Size Pan Capacity	Temperature Range	Cord Length	Amps	HP	NEMA Plug	Crated Weight (lbs.)
	Width	Depth	Height*								
ARCB36	38.0"	32.0"	26.0"	2	2**	33°F to 41°F	6'	2.1	1/3	5-15P	230
ARCB48	50.0"	32.0"	26.0"	2	4	33°F to 41°F	6'	2.1	1/3	5-15P	250
ARCB60	62.0"	32.0"	26.0"	2	6	33°F to 41°F	6'	2.1	1/3	5-15P	270
ARCB72	74.0"	32.0"	26.0"	4	6**	33°F to 41°F	6'	2.1	1/3	5-15P	355

*Height includes 5" for casters

** Additional 1/3 size pans will also fit in these models

PHONE 952-941-2270
FAX 952-941-3066
WEB www.arcticairco.com



DIMENSIONAL DRAWINGS

Specifications subject to change without notice.

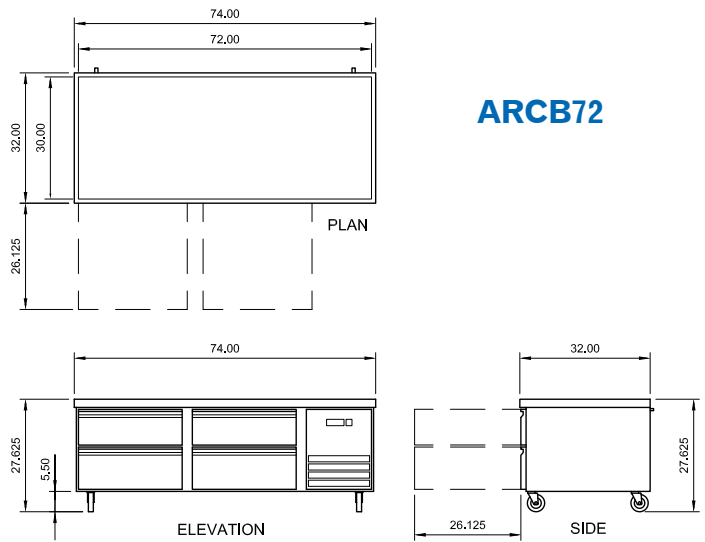
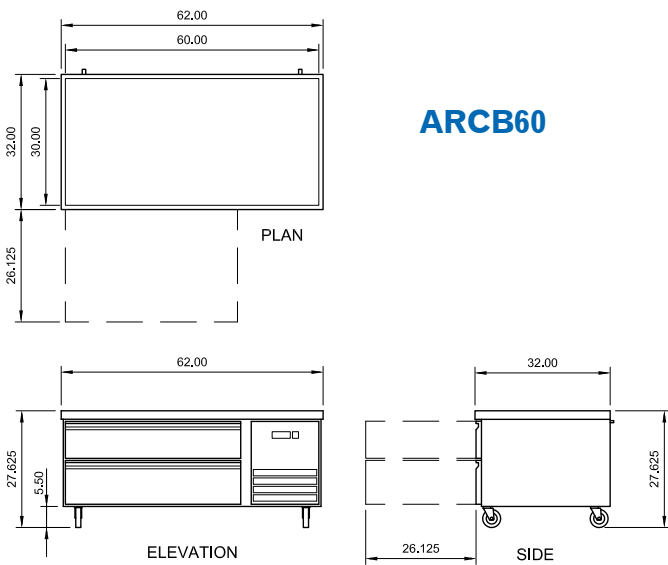
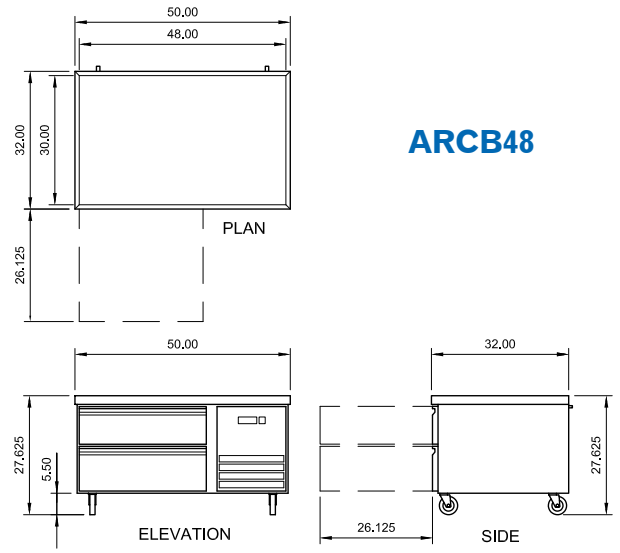
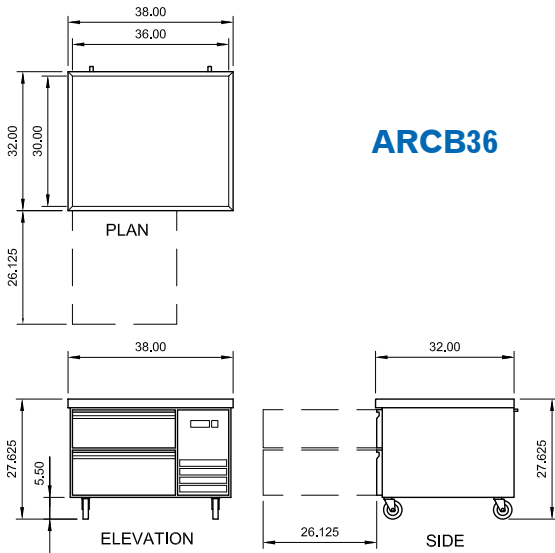

ARCB36 - Two drawers, six pans

- **Top drawer** holds one 12" x 20" x 6" deep pan and two 1/3 size pans 6" deep
- **Bottom drawer** holds one 12" x 20" x 6" deep pan and two 1/3 size pans 6" deep

Total Pans: six

Note: Ships with two 25.5" and two 12.75" s/s pan supports and two 6.75" s/s pan supports.

Part #69230 — 12.75" s/s pan supports are available for fractional pan use.

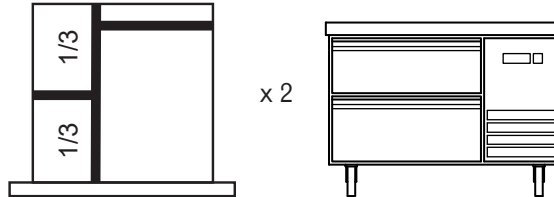

ARCB48 - Two drawers, four pans

- **Top drawer** holds two 12" x 20" x 6" deep pans
- **Bottom drawer** holds two 12" x 20" x 6" deep pans

Total Pans: four

Note: Ships with four 20.5"

Part #69230 — 12.75" s/s pan supports are available for fractional pan use.

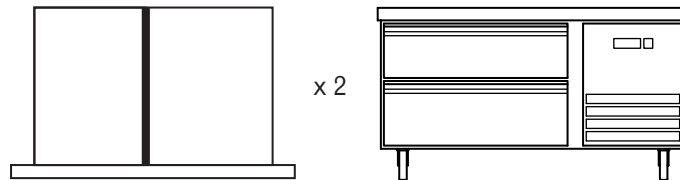

ARCB60 - Two drawer, six pans

- **Top drawer** holds three 12" x 20" x 6" deep pans
- **Bottom drawer** holds three 12" x 20" x 6" deep pans

Total Pans: six

Note: Ships with four 20.5"

Part #69230 — 12.75" s/s pan supports are available for fractional pan use.

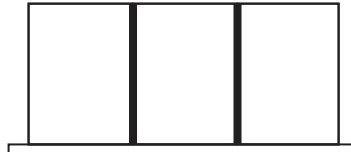

x 2

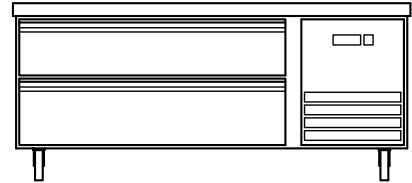

- Four drawer, six pans

- **Top drawer** holds one 12" x 20" x 6" deep pan and two 1/3 size pans 6" deep
- **Bottom drawer** holds one 12" x 20" x 6" deep pan and two 1/3 size pans 6" deep

Total Pans: six

Note: Ships with two 20.5" and two 6.75" s/s pan supports.

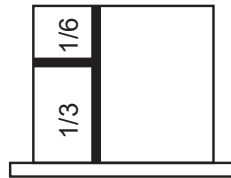

x 2 left side

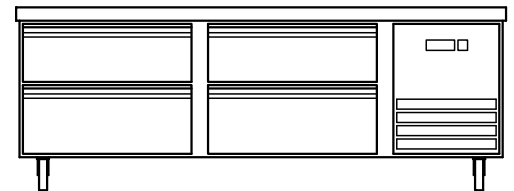

And

ARCB72 - FOUR DRAWER four pan

- **Top drawer** holds two 12" x 20" x 6" deep pans
- **Bottom drawer** holds two 12" x 20" x 6" deep pans

Total Pans: four

Note: Ships with four 20.5"

Part #69230 — 12.75" s/s pan supports are available for fractional pan use.

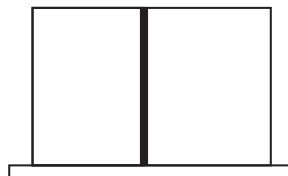

x 2 right side





Undercounter/Worktop Refrigerators and Freezers

- All units come standard with heavy-duty worktop surface.
- Standard top panel is removable for use in lower height applications (reduces total height by 1.5"). Additional wiring changes required.
- Exterior cabinet construction consists of full stainless steel front and sides.
- One/two adjustable, heavy-duty epoxy coated wire shelves.
- Interior cabinet is bright white epoxy coated aluminum sidewall liner with full high-grade stainless steel floor with coved corners.
- Condensate heating element built into condensate pan for efficient evaporation of excess water.
- Electronic thermostat with external digital LED display for accurate control and easy reading
- Easy to mount casters (two lockable) are standard with all units.
- Self-closing doors that remain open at 90 degrees.
- Solid door construction with foamed-in-place recessed handle.
- Magnetic door gaskets are removable and replaceable without tools.
- Larger fan motors and blades for more efficient air flow ensuring faster recovery times.
- Self-contained capillary tube system using environmentally friendly CFC free refrigerant (R290).
- Tested to NSF Standard 7 requirements for open food storage.
- Full two year parts and labor warranty and a five year compressor warranty.

**AUC27R
AUC27F**



**AUC48R
AUC48F**



**AUC60R
AUC60F**



**Approved models:
AUC27R
AUC48R**

Model Number	External Dimensions			Doors	Shelves	Cubic Feet	Temperature Range	Cord Length	HP	Amps	NEMA Plug	Crated Weight (lbs.)
	Width	Depth	Height									
AUC27R	27.875"	30.0"	35.625"	1	1	6.5	33°F to 41°F	8'	3/8	1.5	5-15P	185
AUC27F	27.875"	30.0"	35.625"	1	1	6.5	-11°F to -1°F	8'	1/2	1.9	5-15P	190
Height with worktop panel removed = 34.125"												
AUC48R	48.25"	30.0"	35.625"	2	2	12	33°F to 41°F	8'	3/8	3	5-15P	265
AUC48F	48.25"	30.0"	35.625"	2	2	12	-11°F to -1°F	8'	1/3	2.1	5-15P	285
Height with worktop panel removed = 34.125"												
AUC60R	61.25"	30.0"	35.625"	2	2	15.5	33°F to 41°F	8'	3/8	3	5-15P	305
AUC60F	61.25"	30.0"	35.625"	2	2	15.5	-11°F to -1°F	8'	1/2	5	5-15P	315
Height with worktop panel removed = 34.125"												

PHONE 952-941-2270
FAX 952-941-3066
WEB www.arcticairco.com



Undercounter/Worktop Refrigerators and Freezers

DIMENSIONAL DRAWINGS

Specifications subject to change without notice.

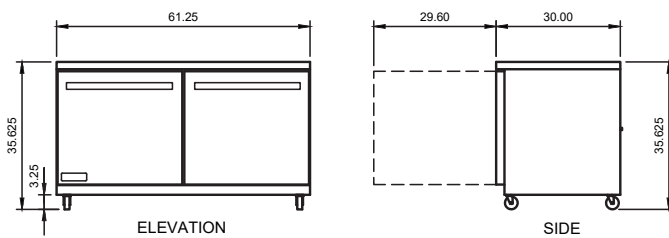
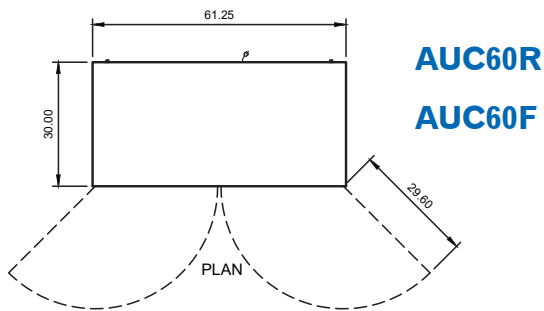
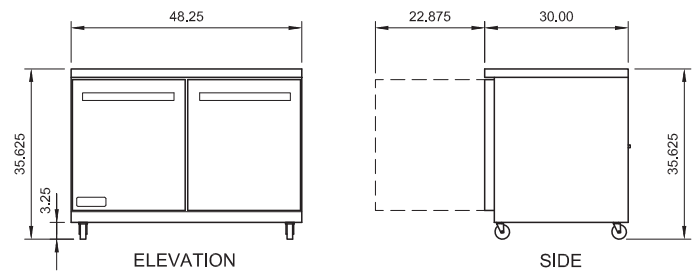
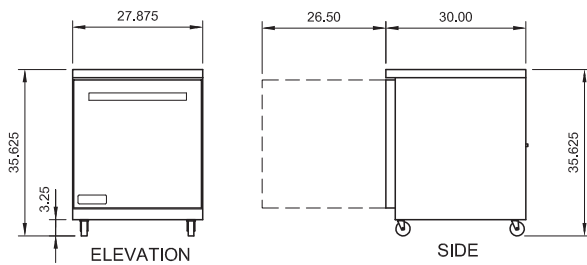
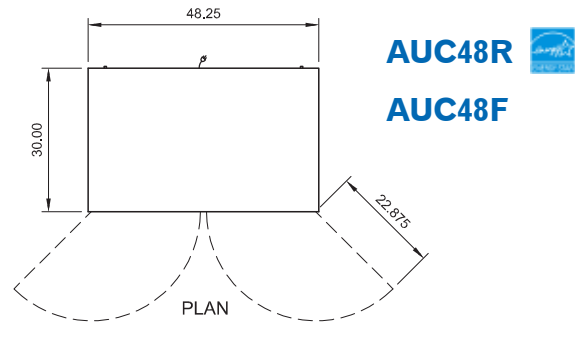
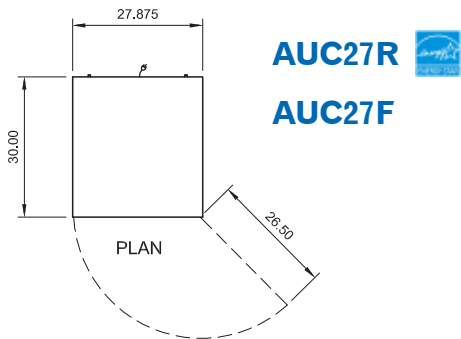

ARCTIC AIR® — A Division of Broich Enterprises, Inc. — An American Company since 1995



- 1/3 size plastic pans included.
- Full length, heavy-duty cutting board is included.
- Self-closing doors that remain open at 90 degrees.
- Solid door construction with foamed-in-place recessed handle.
- Raised pan rail is "air cooled" not "cold wall" heat transfer.
- Exterior cabinet construction consists of full stainless steel front and sides.
- Interior cabinet is bright white epoxy coated aluminum sidewall liner with full high-grade stainless steel floor with coved corners.
- Magnetic door gaskets are removable and replaceable without tools.
- Electronic thermostat with external digital LED display for accurate control and easy reading.
- Easy to mount casters (two locking) are standard with all units.
- Tested to NSF Standard 7 requirements for open food storage.
- Full two year parts and labor warranty and a five year compressor warranty.



APP48R



APP71R



APP94R

Model Number	External Dimensions			Doors	Shelves	Pans	Cubic Feet	Temperature Range	Cord Length	HP	Amps	NEMA Plug	Crated Weight (lbs.)
	Width	Depth*	Height										
APP48R	47.50"	32.25"	41.00"	1	1	6 (1/3)	12	33°F to 41°F	8'	1/2	5	5-15P	310
APP71R	71.00"	32.25"	41.00"	2	2	9 (1/3)	21	33°F to 41°F	8'	1/2	5	5-15P	410
APP94R	94.2"	32.25"	41.00"	3	3	12 (1/3)	32	33°F to 41°F	8'	3/4	5.5	5-15P	515
*Cutting board depth — 17.75"													
*Total depth with cutting board — 35.25"													

PHONE 952-941-2270
FAX 952-941-3066
WEB www.arcticairco.com



DIMENSIONAL DRAWINGS

Specifications subject to change without notice.

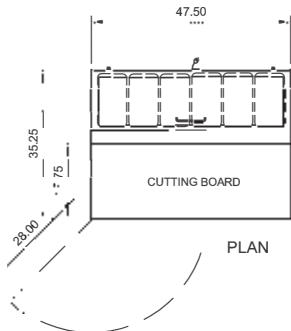

APP48R

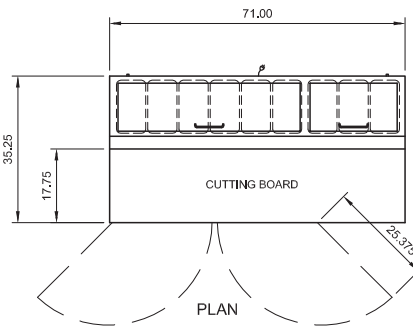

APP71R

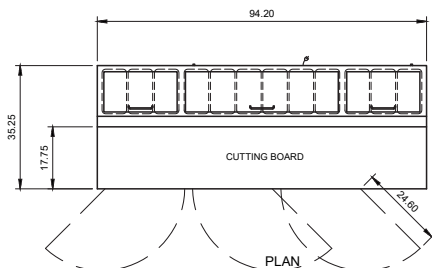
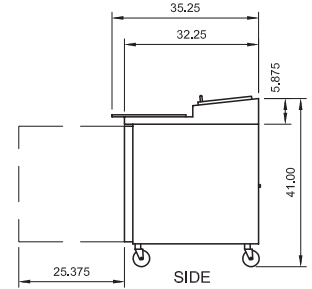
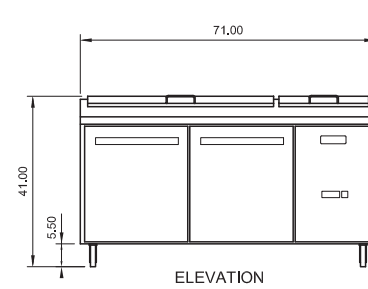
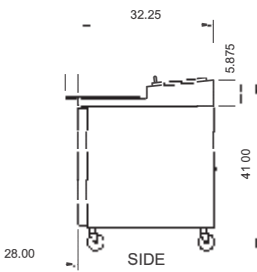
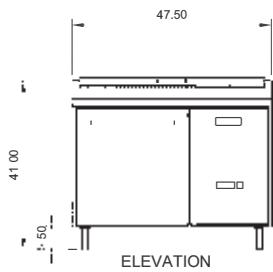

APP94R

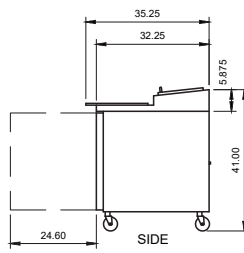
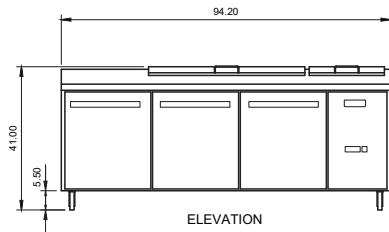



Refrigerated Sandwich/Salad Prep Tables

- 1/6 size 4" deep plastic pans included.
- Full length, heavy-duty cutting board is included.
- Self-closing doors that remain open at 90 degrees.
- Solid door construction with foamed-in-place recessed handle.
- Exterior cabinet construction consists of full stainless steel front and sides.
- Interior cabinet is bright white epoxy coated aluminum sidewall liner with full high-grade stainless steel floor with coved corners.
- Magnetic door gaskets are removable and replaceable without tools.
- Electronic thermostat with external digital LED display for accurate control and easy reading.
- Easy to mount casters (two locking) are standard with all units.
- Tested to NSF Standard 7 requirements for open food storage.
- Full two year parts and labor warranty and a five year compressor warranty.



AST28R



AST48R



AST60R



AST72R

Note:

6" deep pans can be exchanged out for pans by others.

Model Number	External Dimensions			Doors	Shelves	Pans	Cubic Feet	Temperature Range	Cord Length	HP	Amps	NEMA Plug	Crated Weight (lbs.)
	Width	Depth	Height										
AST28R	29.00"	30.00"	43.30"	1	1	8 (1/6)	6.5	33°F to 41°F	8'	1/3	3	5-15P	215
AST48R	48.25"	30.00"	43.30"	2	2	12 (1/6)	12	33°F to 41°F	8'	1/2	4.3	5-15P	300
AST60R	61.25"	30.00"	43.30"	2	2	16 (1/6)	15.5	33°F to 41°F	8'	1/2	4.3	5-15P	385
AST72R	71.5"	30.00"	43.30"	3	3	18 (1/6)	18	33°F to 41°F	8'	1/2	4.3	5-15P	425

PHONE 952-941-2270
FAX 952-941-3066
WEB www.arcticairco.com



DIMENSIONAL DRAWINGS

Specifications subject to change without notice.

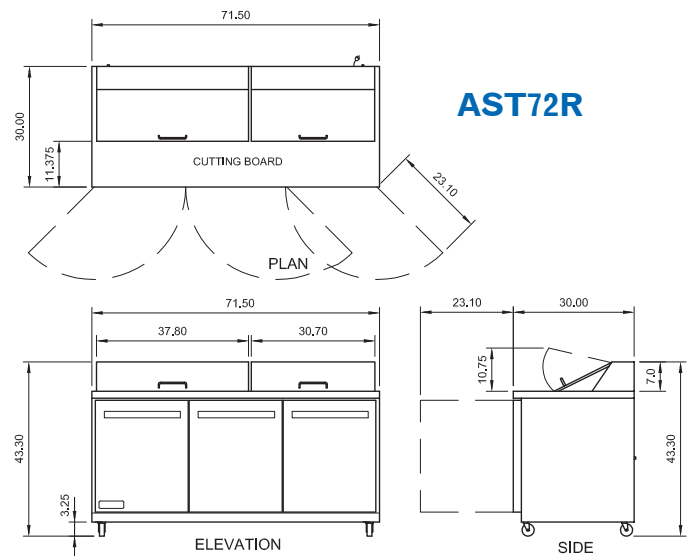
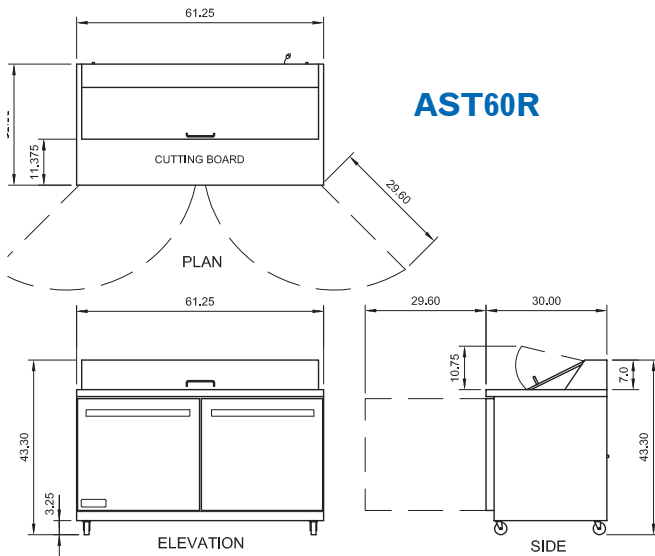
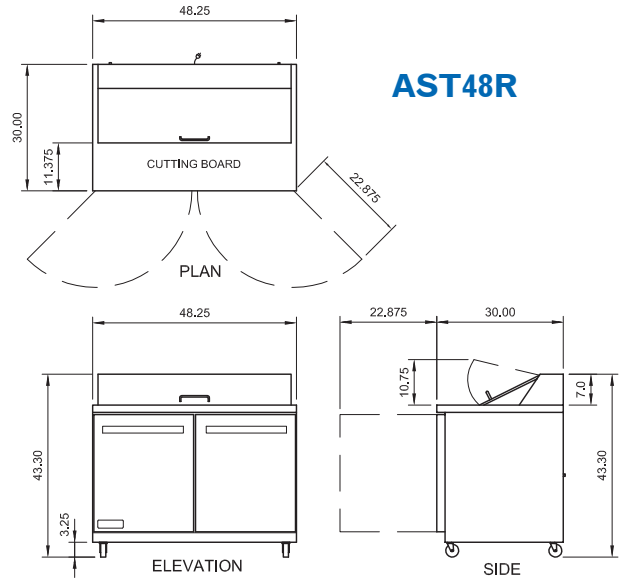
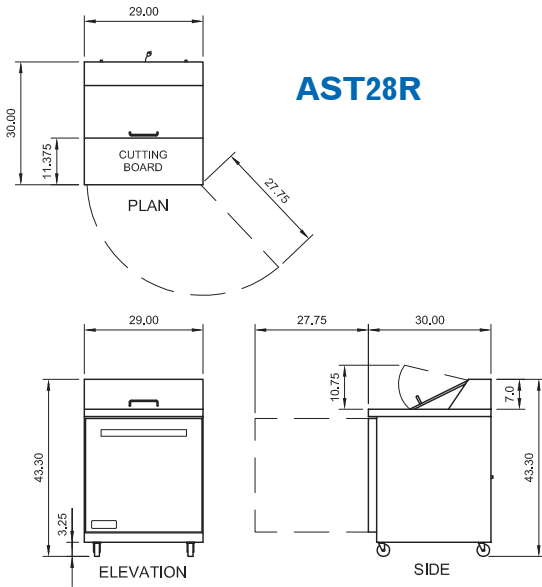



Refrigerated Mega-Top Sandwich/Salad Prep Tables

- Added space allows for extra rows of pans.
- 1/6 size plastic pans included.
- Full length, heavy-duty cutting board is included.
- Self-closing doors that remain open at 90 degrees.
- Solid door construction with foamed-in-place recessed handle.
- Exterior cabinet construction consists of full stainless steel front and sides.
- Interior cabinet is bright white epoxy coated aluminum sidewall liner with full high-grade stainless steel floor with coved corners.
- Magnetic door gaskets are removable and replaceable without tools.
- Electronic thermostat with external digital LED display for accurate control and easy reading.
- Easy to mount casters (two locking) are standard with all units.
- Tested to NSF Standard 7 requirements for open food storage.
- Full two year parts and labor warranty and a five year compressor warranty.

Note:
6" deep pans can be exchanged out for pans by others.



Model Number	External Dimensions			Doors	Shelves	Pans	Cubic Feet	Temperature Range	Cord Length	HP	Amps	NEMA Plug	Crated Weight (lbs.)
	Width	Depth	Height										
AMT28R	29.00"	34.50"	43.30"	1	1	12 (1/6)	6.5	33°F to 41°F	8'	1/3	3	5-15P	230
	Cutting board depth — 9.0"												
AMT48R	48.25"	34.50"	43.30"	2	2	18 (1/6)	12.0	33°F to 41°F	8'	1/2	4.3	5-15P	320
	Cutting board depth — 9.0"												
AMT60R	61.25"	34.50"	43.30"	2	2	24 (1/6)	15.5	33°F to 41°F	8'	1/2	4.3	5-15P	385
	Cutting board depth — 9.0"												
AMT72R	71.50"	34.50"	43.30"	3	3	27 (1/6)	18.0	33°F to 41°F	8'	1/2	4.3	5-15P	450
	Cutting board depth — 9.0"												

PHONE 952-941-2270
FAX 952-941-3066
WEB www.arcticairco.com



Refrigerated Mega-Top Sandwich/Salad Prep Tables

DIMENSIONAL DRAWINGS

Specifications subject to change without notice.

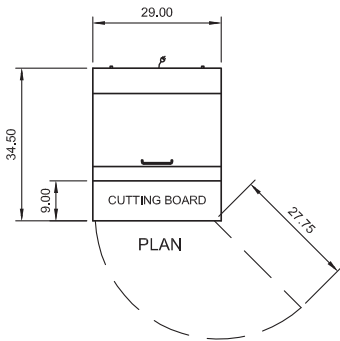

AMT28R

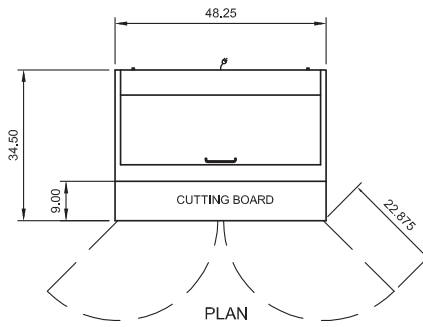

AMT48R

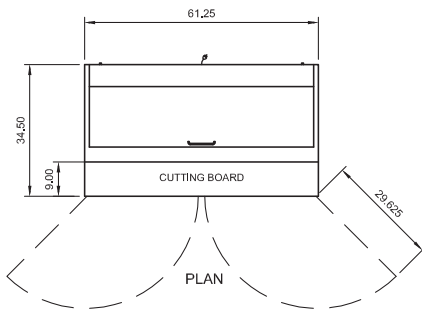
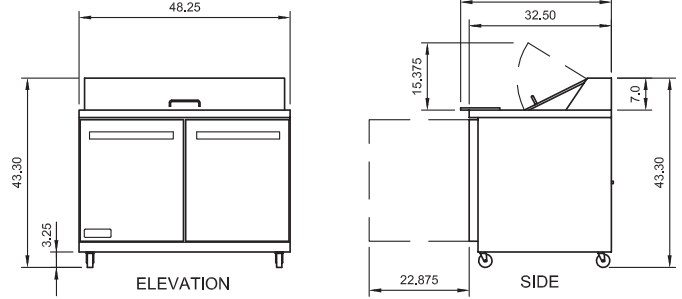
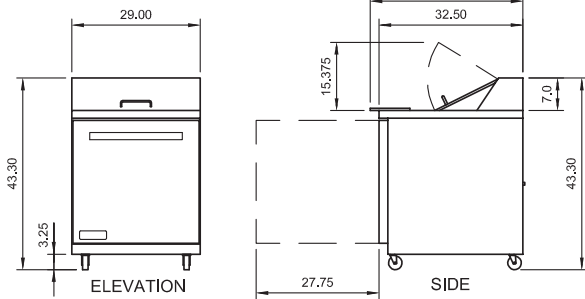

AMT60R

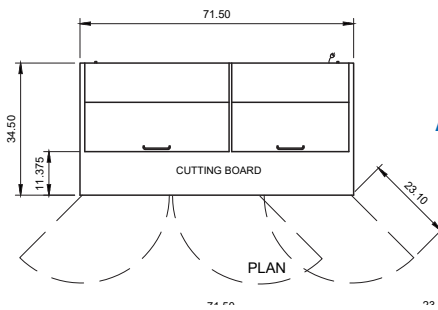

AMT72R

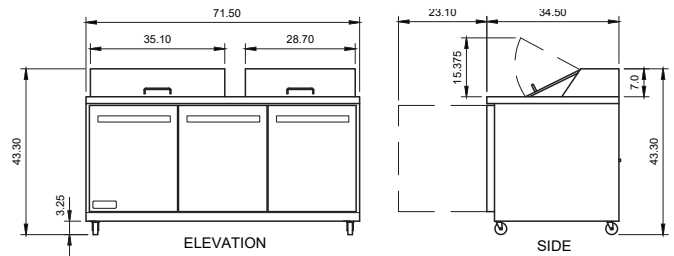
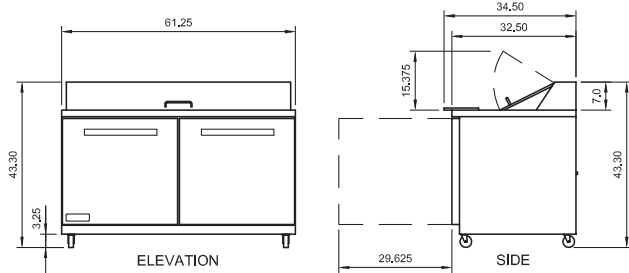

ARCTIC AIR® — A Division of Broich Enterprises, Inc. — An American Company since 1995



- Top is 1.5" solid foamed stainless steel.
- Self-contained capillary tube system using environmentally friendly CFC free refrigerant (R290).
- Front accessible condensing unit for easy cleaning and maintenance.
- Front breathing.
- Easy to mount casters (two lockable) are standard with all units.
- Electronic thermostat with digital LED display for accurate control located behind front access panel.
- Each door is equipped with magnetic gaskets that are removable for cleaning.
- 24" depth conserves important work space.
- Interior LED lighting.
- Mirror finish stainless steel interior with high-grade stainless steel covered corner floor.
- Exterior cabinet construction consists of black powder coated steel front and sides.
- Tested to NSF Standard 7 requirements for open food storage.
- Full two year parts and labor warranty and a five year compressor warranty.

Optional larger 5.75" casters available (#67000K) Set of four.



ABB48



ABB60



ABB72

Model Number	External Dimensions			Doors	Temperature Range	Cord Length	12 oz. Cans	Amps	HP	NEMA Plug	Crated Weight (lbs.)
	Width	Depth	Height*								
ABB48	49.125"	24.0"	39.625"	2	33°F to 41°F	7'	48 6-pk	3	2/5	5-15P	280
ABB60	61.125"	24.0"	39.625"	2	33°F to 41°F	7'	72 6-pk	3	2/5	5-15P	320
ABB72	73.125"	24.0"	39.625"	3	33°F to 41°F	7'	84 6-pk	3	2/5	5-15P	360

*Height includes 3.375" for casters

PHONE 952-941-2270
FAX 952-941-3066
WEB www.arcticairco.com



DIMENSIONAL DRAWINGS

Specifications subject to change without notice.

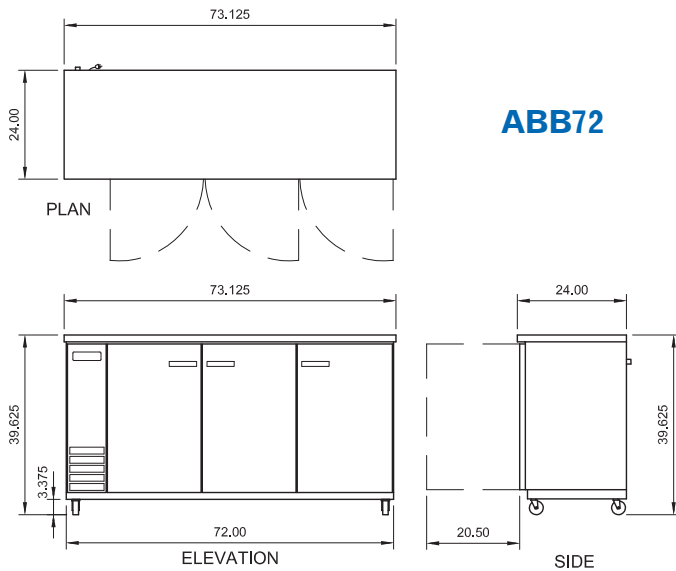
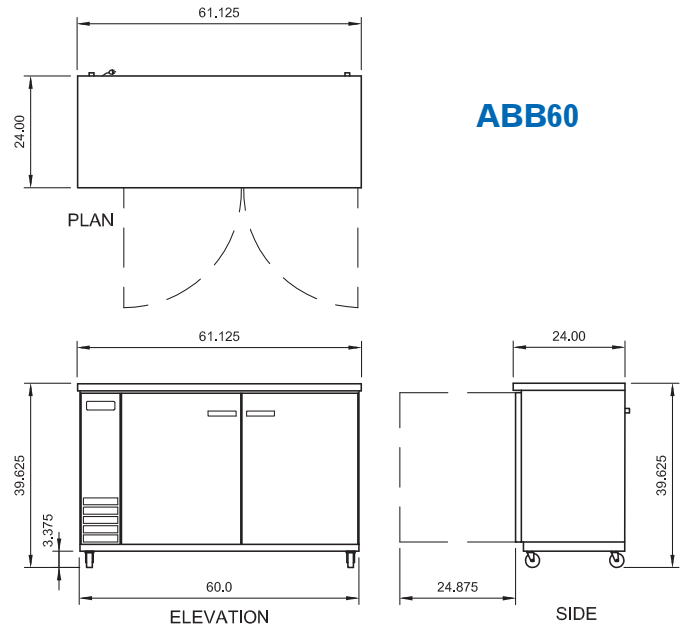
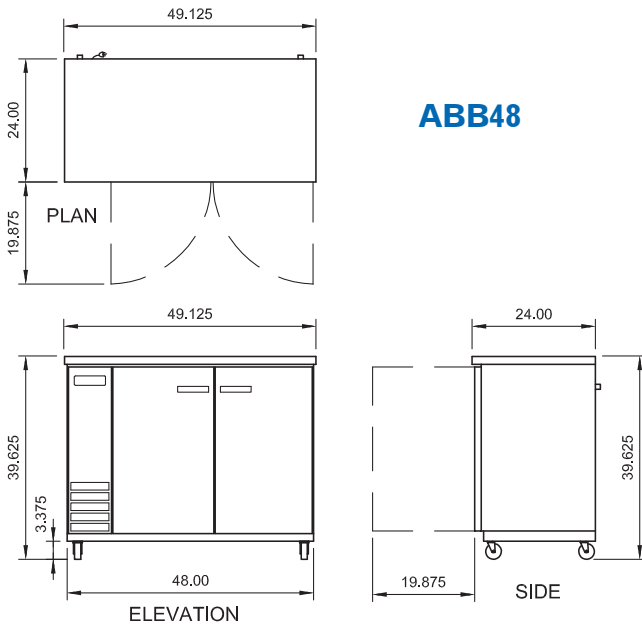



Refrigerated Glass Door Back Bar Coolers

- Top is 1.5" solid foamed stainless steel.
- Self-contained capillary tube system using environmentally friendly CFC free refrigerant (R290).
- Front accessible condensing unit for easy cleaning and maintenance.
- Front breathing.
- Easy to mount casters (two lockable) are standard with all units.
- Electronic thermostat with digital LED display for accurate control located behind front access panel.
- Each door is equipped with magnetic gaskets that are removable for cleaning.
- 24" depth conserves important work space.
- Interior LED lighting.
- Mirror finish stainless steel interior with high-grade stainless steel covered corner floor.
- Exterior cabinet construction consists of black powder coated steel front and sides.
- Tested to NSF Standard 7 requirements for open food storage.
- Full two year parts and labor warranty and a five year compressor warranty.

Optional larger 5.75" casters available (#67000K) Set of four.



ABB48G



ABB60G



ABB 72G

Model Number	External Dimensions			Doors	Temperature Range	Cord Length	12 oz. Cans	Amps	HP	NEMA Plug	Crated Weight (lbs.)
	Width	Depth	Height*								
ABB48G	49.125"	24.0"	39.625"	2	33°F to 41°F	7'	48 6-pk	3	2/5	5-15P	320
ABB60G	61.125"	24.0"	39.625"	2	33°F to 41°F	7'	72 6-pk	3	2/5	5-15P	365
ABB72G	73.125"	24.0"	39.625"	3	33°F to 41°F	7'	84 6-pk	3	2/5	5-15P	410

*Height includes 3.375" for casters

PHONE 952-941-2270
FAX 952-941-3066
WEB www.arcticairco.com



DIMENSIONAL DRAWINGS

Specifications subject to change without notice.

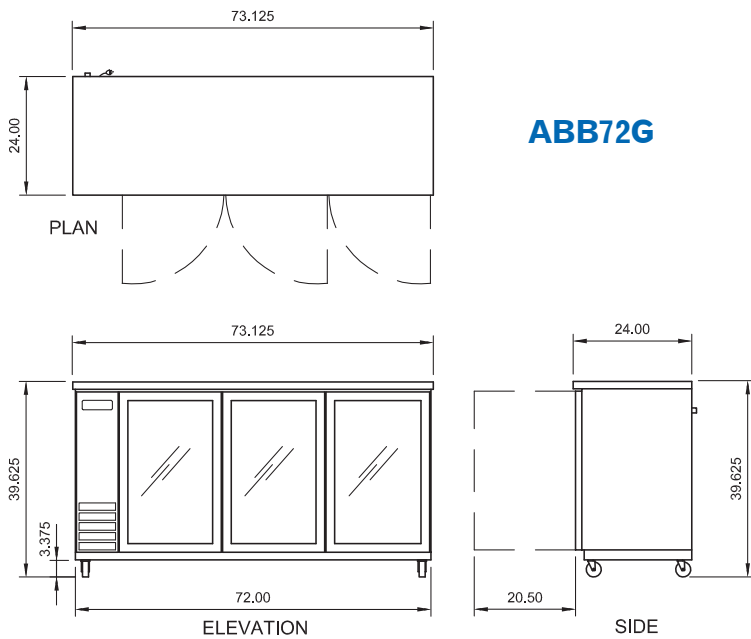
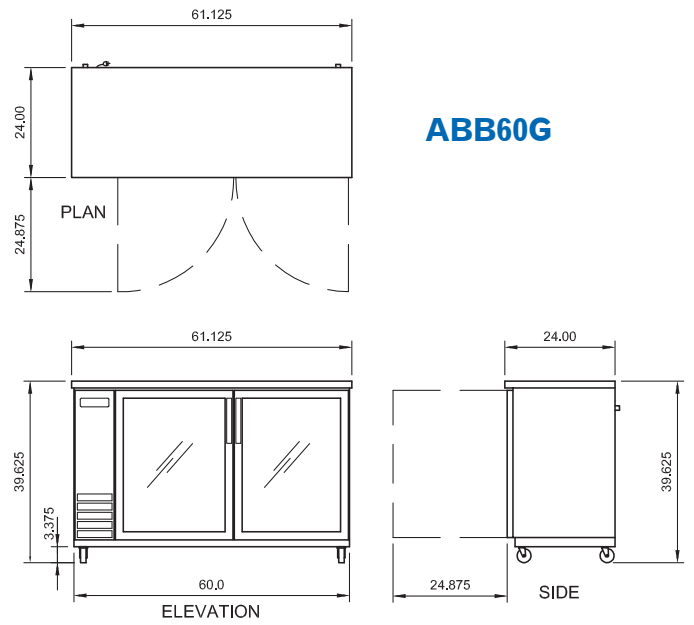
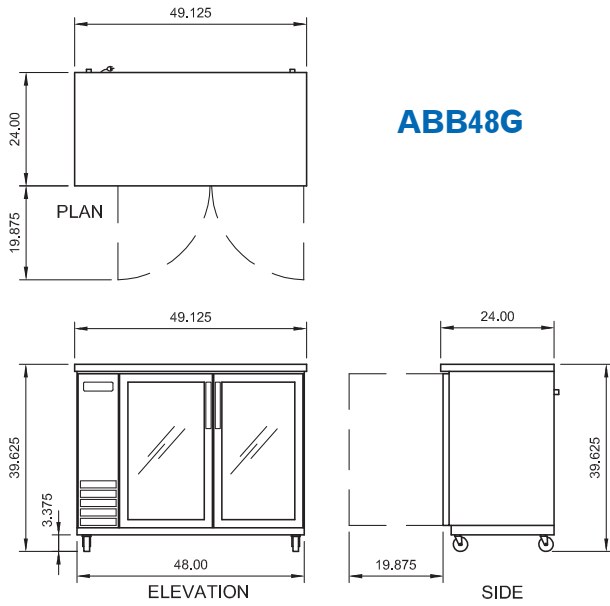



Refrigerated Direct Draw Beer Coolers

- All models standard with two towers and two faucets per tower.
- Top is 1.5" solid foamed stainless steel.
- Electronic thermostat with digital LED display for accurate control located behind front access panel.
- Self-contained capillary tube system using environmentally friendly CFC free refrigerant (R290).
- Front breathing.
- Front accessible condensing unit for easy cleaning and maintenance.
- High-grade reinforced stainless steel coved corner floor.
- External drain mount.
- Easy to mount 3.25" casters (two lockable) are standard with all units.
- Mounted 4-way air distributor.
- Interior LED lighting.
- Bright mirror finish stainless steel interior.
- 24" depth conserves important work space.
- Each door is equipped with locks and magnetic gaskets that are removable for cleaning.
- Exterior cabinet construction consists of black powder coated steel front and sides.
- Tested to NSF Standard 7.
- Full two year parts and labor warranty and a five year compressor warranty.



ADD48R-2



ADD60R-2



ADD72R-2

All models include internal air and liquid hoses (keg couplers, gauges and CO2 tanks supplied by others)

Optional larger 5.75" casters available (#67000K) Set of four.

Model Number	External Dimensions			Doors	Temperature Range	Cord Length	Amps	HP	NEMA Plug	Crated Weight (lbs.)
	Width	Depth	Height*							
ADD48R-2	49.0"	24.0"	39.5"	2	33°F to 41°F	7'	3	2/5	5-15P	290
ADD60R-2	61.0"	24.0"	39.5"	2	33°F to 41°F	7'	3	2/5	5-15P	325
ADD72R-2	73.0"	24.0"	39.5"	3	33°F to 41°F	7'	3	2/5	5-15P	375

*Height includes 3.25" for casters

PHONE 952-941-2270
FAX 952-941-3066
WEB www.arcticairco.com



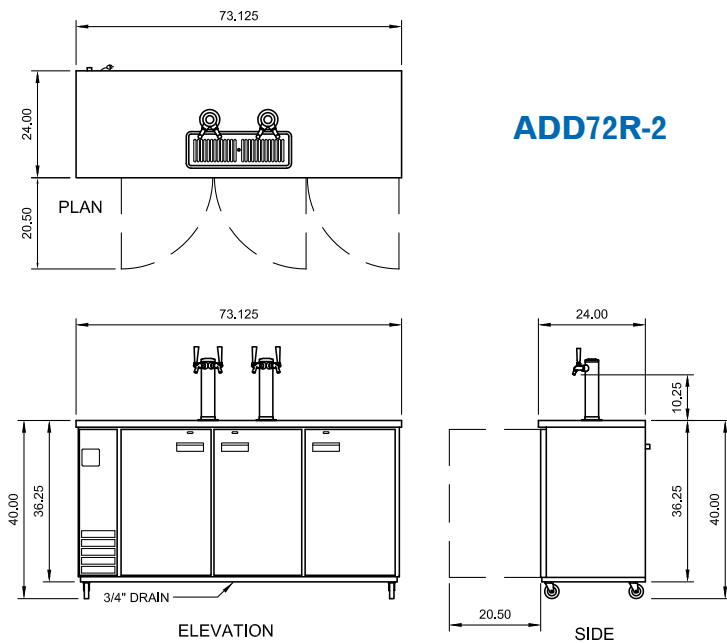
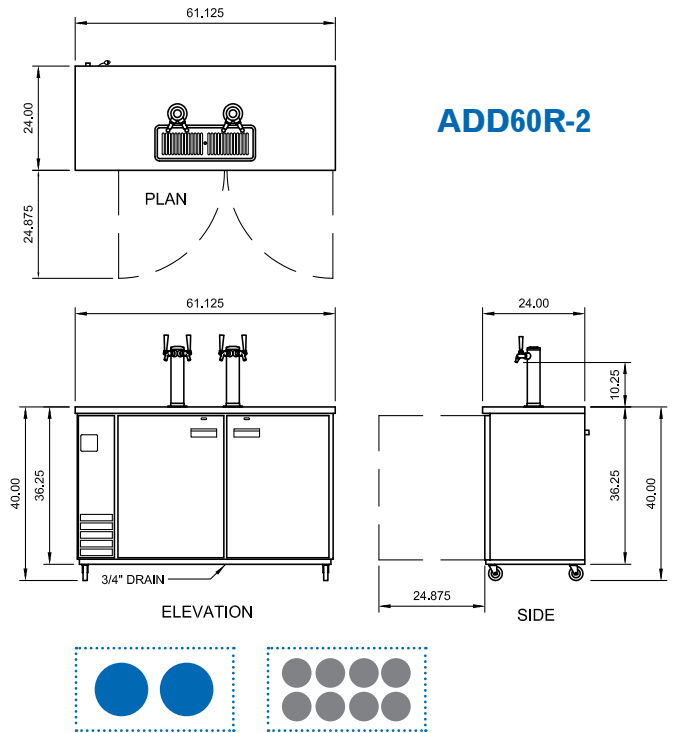
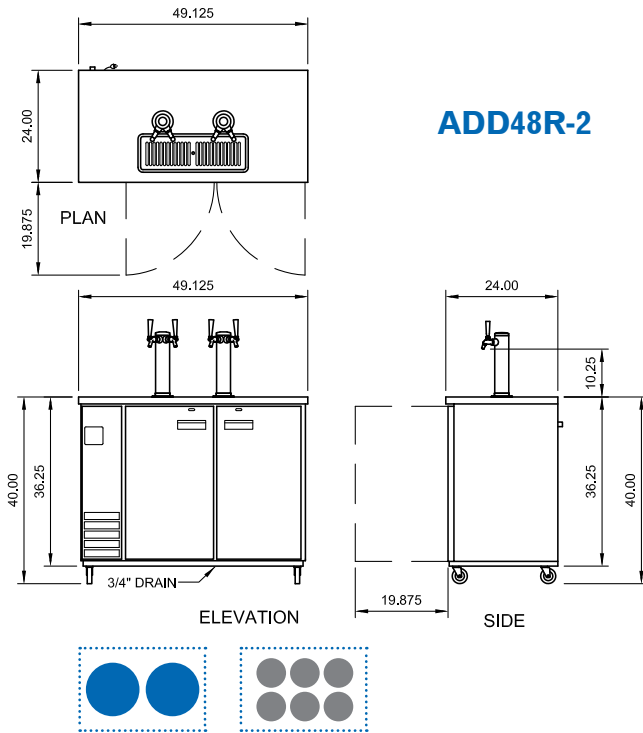

DIMENSIONAL DRAWINGS

Specifications subject to change without notice.



KEG SIZE COLOR KEY

-  Standard Half Keg
-  1/4 Slim Keg



- *Electronic thermostat with digital LED display for accurate control located behind front access panel.*
- *Exterior cabinet construction consists of black powder coated steel front and sides.*
- *Self-contained capillary tube system using environmentally friendly CFC free refrigerant (R290).*
- *Easy to mount casters (two lockable) are standard with all units.*
- *Stainless steel sliding lids with locks.*
- *Stainless steel bottle opener and cap catcher included.*
- *24" depth conserves important work space.*
- *Interior LED lighting.*
- *Bright mirror finish stainless steel interior with high-grade stainless steel coved corner floor.*
- *Front accessible condensing unit for easy cleaning and maintenance.*
- *Front breathing.*
- *Tested to NSF Standard 7 requirements for open food storage.*
- *Full two year parts and labor warranty and a five year compressor warranty.*

Model AUB36R has 0 can dividers.
Model AUB50R has 2 can dividers.
Model AUB65R has 3 can dividers.
 (Part #69436)

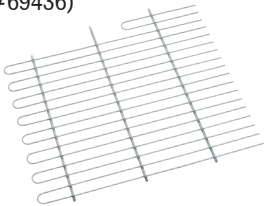

AUB36R



AUB50R



AUB65R



Model Number	External Dimensions			Sliding lids with locks	Temperature Range	Capacity 12 oz. bottles/cans	Cord Length	Amps	HP	NEMA Plug	Crated Weight (lbs.)
	Width	Depth	Height*								
AUB36R	36.8"	27.0"	36.5"	1	33°F to 41°F	11/14.5 cases	7'	1.8	3/8	5-15P	260
AUB50R	49.4"	27.0"	36.5"	2	33°F to 41°F	16.5/24 cases	7'	3	1/2	5-15P	315
AUB65R	64.3"	27.0"	36.5"	2	33°F to 41°F	22/32.5 cases	7'	3	1/2	5-15P	365

*Height includes 3.5" for casters

PHONE 952-941-2270
FAX 952-941-3066
WEB www.arcticairco.com



DIMENSIONAL DRAWINGS

Specifications subject to change without notice.

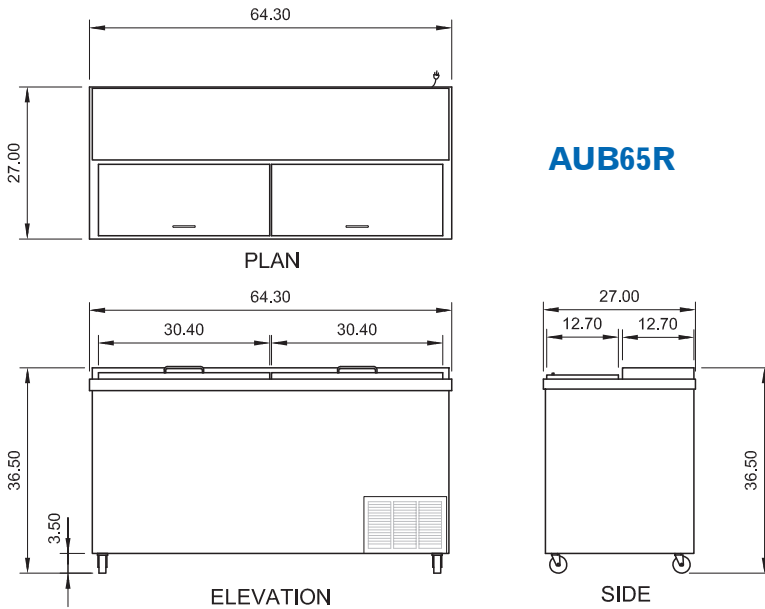
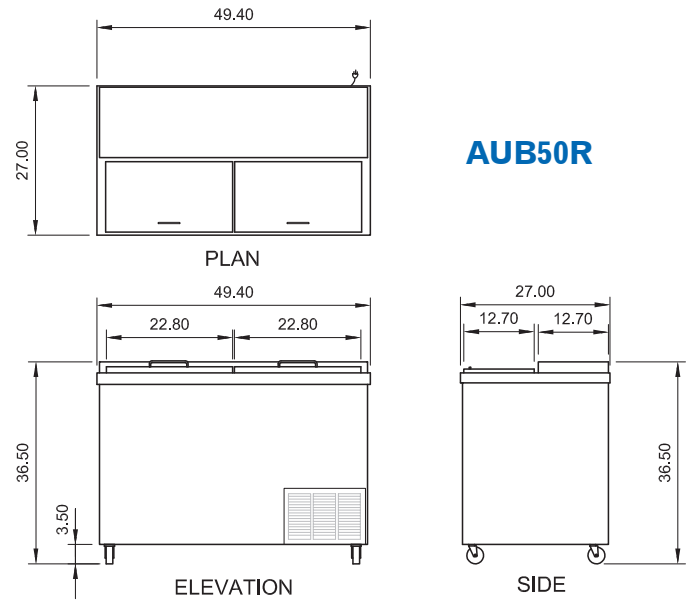
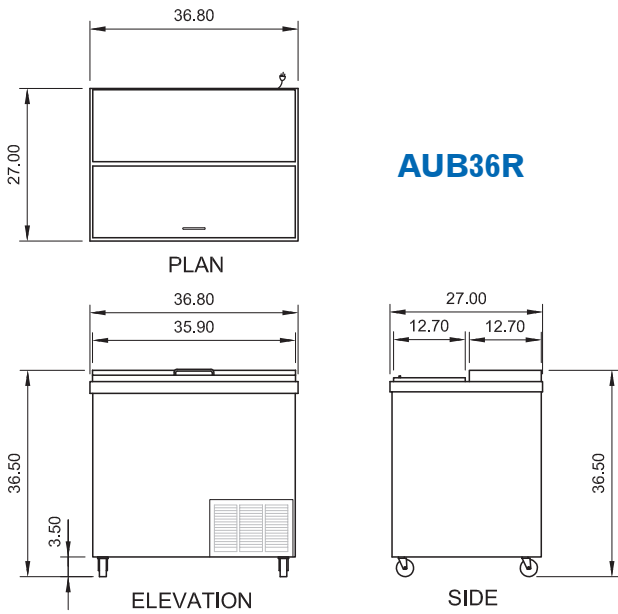



Glass Mug Froster Freezer

- *Electronic thermostat with digital LED display for accurate control located behind front access panel.*
- *Exterior cabinet construction consists of black powder coated steel front and sides.*
- *Self-contained capillary tube system using environmentally friendly R290 hydrocarbon gas.*
- *Convenient internal drain located near the front left corner and the corresponding external drain located on bottom left.*
- *Easy to mount casters (two lockable) are standard with all units.*
- *Stainless steel sliding lids with locks.*
- *White epoxy coated aluminum interior sidewalls.*
- *High grade stainless steel covered corner interior floor.*
- *Front accessible condensing unit for easy cleaning and maintenance.*
- *Arctic Air products must pass numerous quality control inspections throughout the manufacturing process.*
- *All products are operated and monitored for a minimum of thirteen hours prior to packaging and shipping.*
- *Tested to NSF Standard 7.*
- *Full two year parts and labor warranty and a five year compressor warranty.*



AGF24



AGF36

Model Number	External Dimensions			Epoxy Coated Horizontal Shelves	16 oz. Std. Pilsner Glasses	Temperature Range	Cord Length	Amps	HP	REF	NEMA Plug	Crated Weight (lbs.)
	Width	Depth	Height*									
AGF24	24.0"	27.0"	36.5"	1 Full 2 (1/2)	50	-10°F to 10°F	8'	2	1/3	R290	5-15P	155
AGF36	36.8"	27.0"	36.5"	1 Full 3 (1/2)	70	-10°F to 10°F	8'	2	1/3	R290	5-15P	195

*Height includes 3.25" for casters

PHONE 952-941-2270
FAX 952-941-3066
WEB www.arcticairco.com



DIMENSIONAL DRAWINGS

Specifications subject to change without notice.

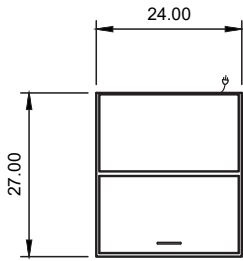

AGF24

PLAN

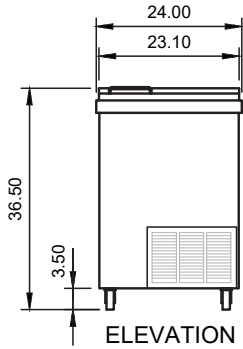

ELEVATION

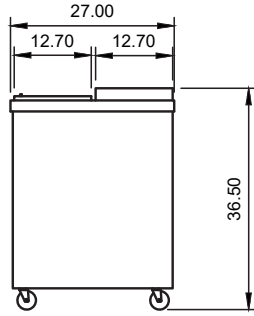

SIDE

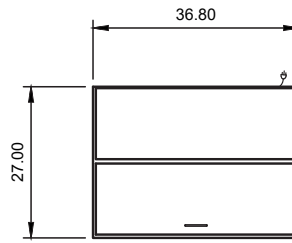

AGF36

PLAN

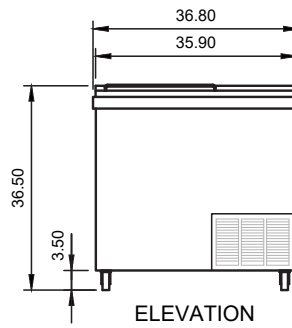

ELEVATION

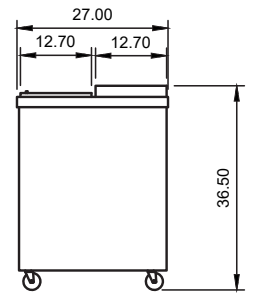

SIDE





Arctic Air Warranty

Two-year parts and labor warranty*

Arctic Air warrants, to the original purchaser, all qualifying models of its new equipment to be free from defects in material or workmanship, under normal use and maintenance service, for a period of two (2) years from the date of original purchase or 30 months after shipment date from the manufacturer, whichever occurs first. Warranty coverage is limited to the repair and/or replacement, including labor charges, of defective parts and/or assemblies. The labor warranty shall include straight time labor charges and travel charges within 100 miles roundtrip.

* Exclusions:

- Any Arctic Air model installed in mobile application such as concession trailers, food trucks, etc. or in an outdoor venue shall be limited to one (1) year parts, labor, and compressor warranty only.
- **Models AWR25, AWF25, ACP40, ACP48, ACP55, ACP63, ACP4SQ, and ACPSQ are limited to one (1) year parts and labor coverage.**
- **Light bulbs and door gaskets are limited to 90-day warranty period and door hinges to one (1) year period.**

Additional three-year compressor warranty*

In addition to the two (2) year warranty stated above, Arctic Air warrants its compressor units to be free from defects in both material and workmanship under normal and proper use and maintenance service for a period of three (3) additional years from the date of original installation but not to exceed five (5) years and three (3) months after shipment from Arctic Air.

The three (3) year extended compressor warranty applies only to the compressor part itself and does not apply to any other parts, components, or labor charges involved in replacement of compressor. In addition, shipping charges for replacement compressors in the extended three-year period are not covered by this warranty and compressor replacement is limited to one (1) compressor during the three-year period.

***(Not applicable for ACP counter-top models and/or any model being used in mobile/outdoor use application)**

Conditions

All service under this warranty, for either labor or parts, must be performed by a preferred service provider arranged by the Arctic Air Warranty Center at 1-855-431-5558. Proof of purchase will be required to validate warranty coverage dates. Service coverage is limited to units located in the United States and Canada only.

Limitations and Exclusive Warranty

This parts and labor warranty is the sole and exclusive warranty remedy offered by Arctic Air. Arctic Air's sole obligation under this warranty is limited to either repair or replacement of parts and is subject to the limitations listed below.

Arctic Air will bear no responsibility or liability for any equipment which has been misapplied, mishandled, misused, subjected to harsh chemical action, or external causes such as the use of extension cords, electrical power fluctuations, lack of proper maintenance, non-factory approved revisions or modifications, or equipment damaged by fire, flood, or other acts of God.

1. Arctic Air will bear no responsibility for consequential loss or damages such as, including but not limited to, economic loss, profit loss, personal injury, property damage, damage during transit, losses or damages arising from food or product spoilage claims.
2. Arctic Air shall bear no responsibility for parts or labor coverage for component failure or other damages resulting from improper usage, installation, or maintenance as described in the owner's manual. In addition, charges that include but are not limited to ferry charges, city torch/burn permits, or labor time to access mobile units are not covered by this warranty.
3. Arctic Air equipment is intended for commercial use only and this warranty is void if the equipment is installed in other than commercial applications.
4. All other warranties, either express or implied, arising under law or equity or custom of the trade, including but not limited to, warranties or merchantability or fitness for a particular purpose are excluded.



ARCTIC AIR® — A Division of Broich Enterprises, Inc. — An American Company since 1995

PHONE 952-941-2270
FAX 952-941-3066
WEB www.arcticairco.com

© 2022 Broich Enterprises. All rights reserved. Arctic Air Brand and Logo are registered trademarks of Broich Enterprises. Prices and products subject to change without prior written notice.



COMMERCIAL FREEZERS & REFRIGERATORS

ARCTIC AIR® — A Division of Broich Enterprises, Inc. — An American Company since 1995



7550 Market Place Drive, Eden Prairie, MN 55344

PHONE 952-941-2270

FAX 952-941-3066

WEB www.arcticairco.com